

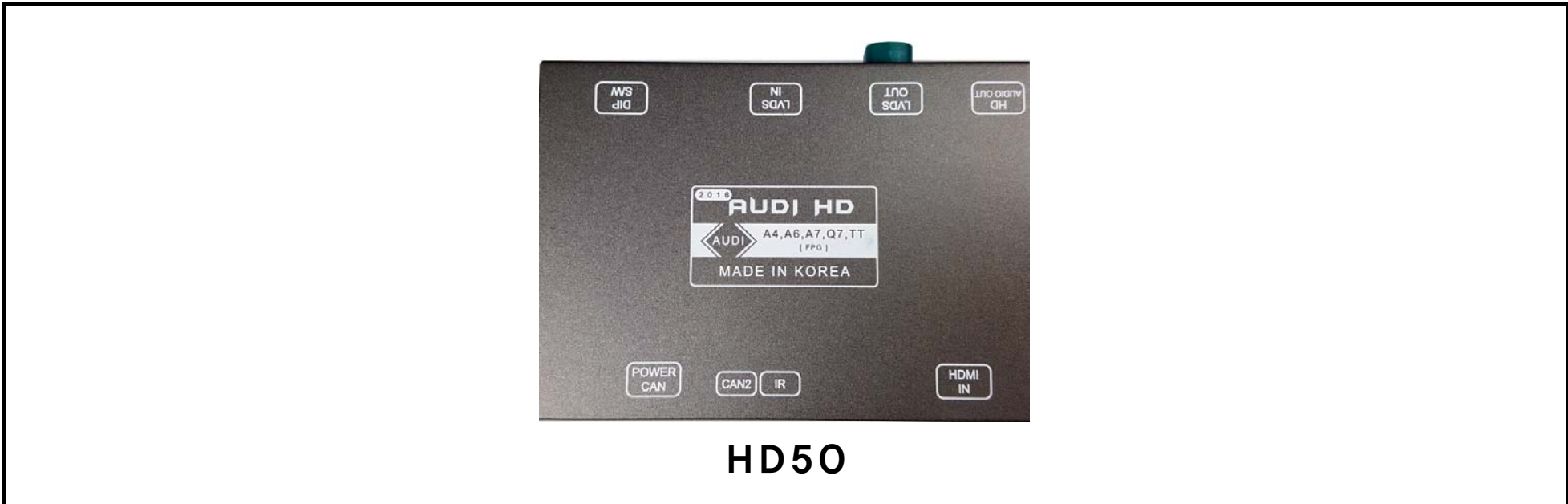

[HD50]

2016 AUDI A4, A6, A7, TT, Q7
MANUAL







■ Main Unit of Interface



HD50

Car Brand	Model	Year Range	System
AUDI	A4, A6, A7 TT, Q7	2016	

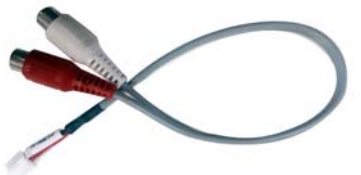
COMPONENTS

1 MAIN UNIT 	2 MAIN CABLE 	3 IR CABLE 	4 LVDS CABLE (A TYPE) 
5 HDMI AUDIO CABLE 	6 REMOTE CONTROL 		

How to connect

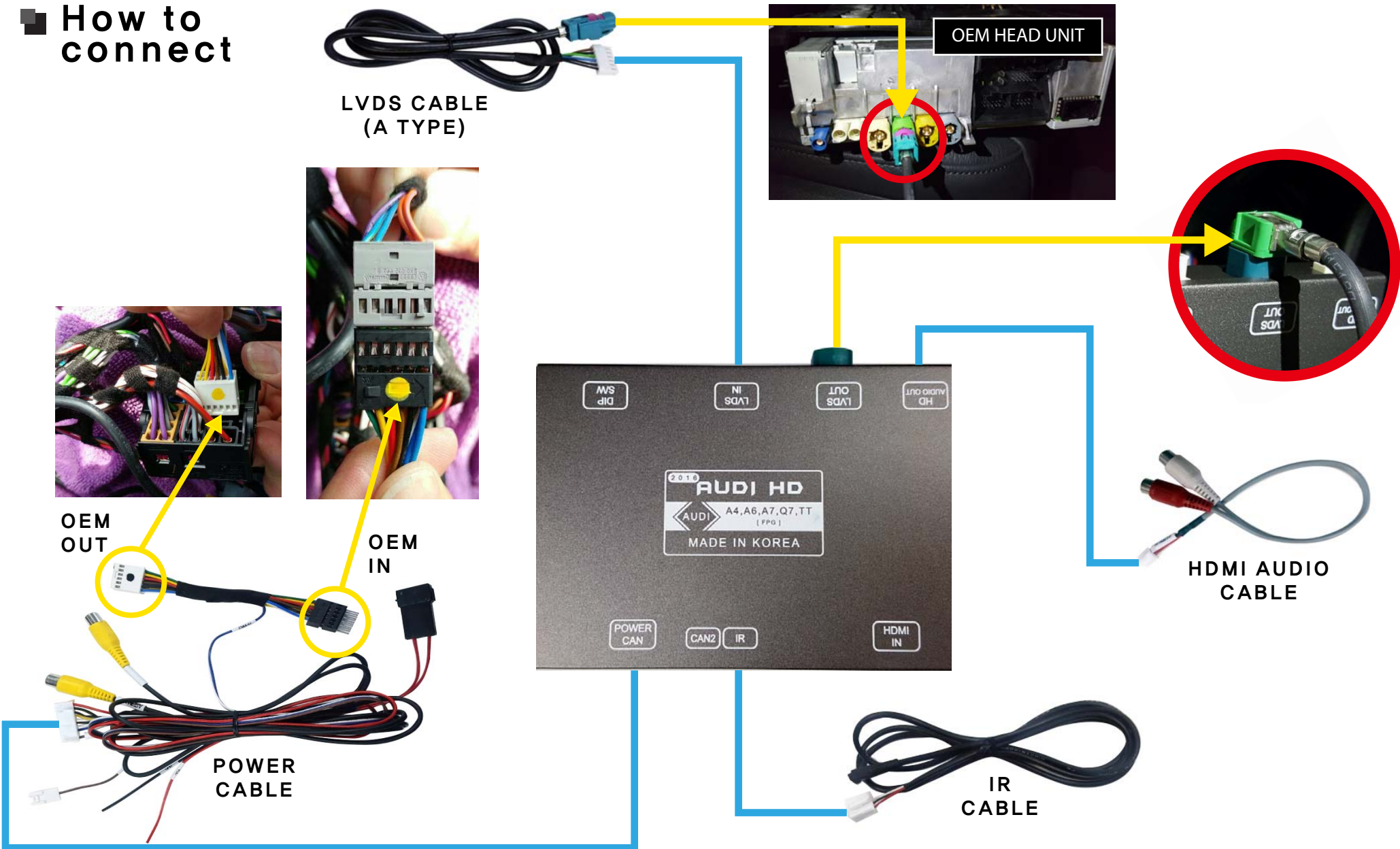

DIP S/W

OFF : ↑ (UP) / ON : ↓ (DOWN)

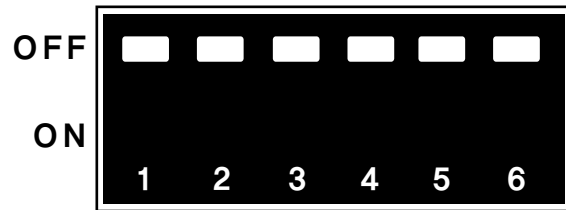

PIN	FUNCTION	DIP S/W SETTING
1	HDMI setting	OFF : HDMI OFF
		ON : HDMI ON
2	Vehicle setting	OFF : A4, Q7, A6, A7
		ON : TT
3	Switch screen	OFF : Press button for switching screen
		ON : Press button for switching screen
4	Gear setting	OFF : automation car
		ON : manual
5		OFF
6		ON

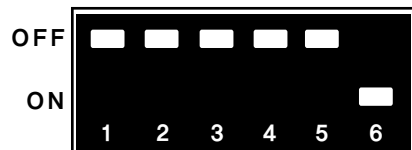

AUDI A4, A6, A7, TT, Q7 2016

AUDI HD(HD50) SPEC

1. INPUT SPEC

- 1 x LVDS output
- 1 x CVBS(rear camera)
- 1 x CVBS(front camera or A/V)

2. POWER SPEC

- Input power : 8VDC ~ 18VDC
- Consumption : 5WATT

3. SIZE

123*88*20mm(Width*Length*Height)

4. POWER 10pin

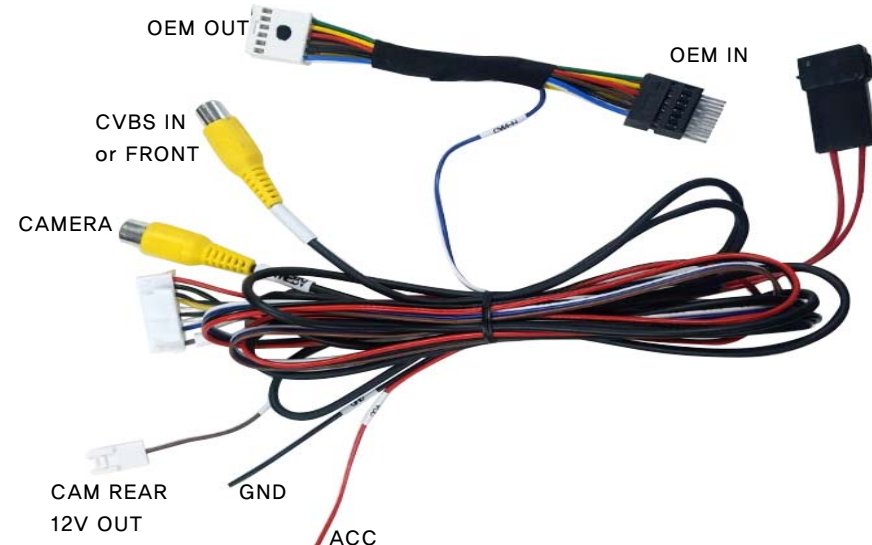

■ How to connect



1. Please use video in of interface insert into connector **A** of head unit.



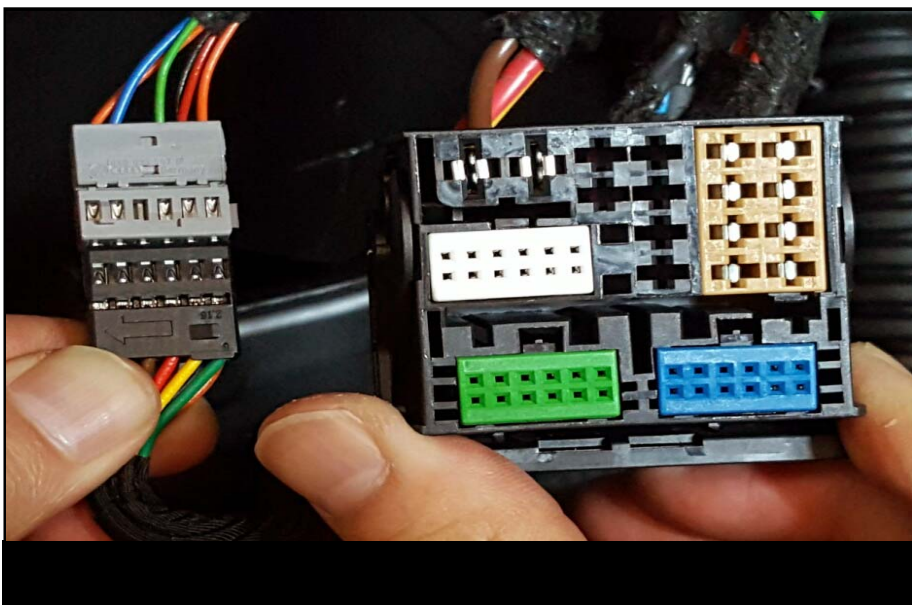

2. Please insert connector of interface with the black point on the upward direction.

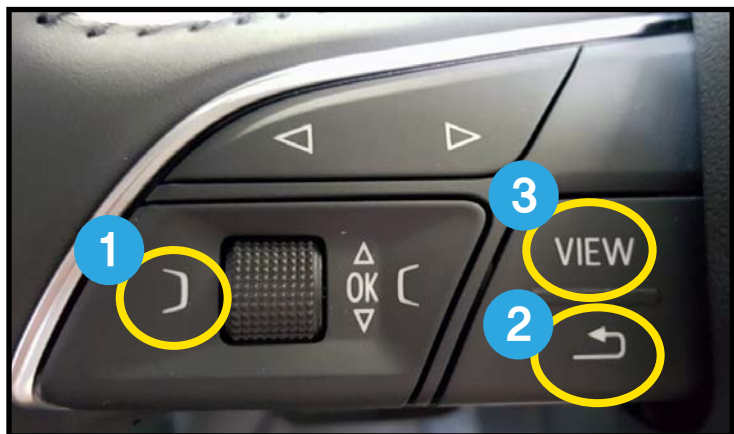

How to switch screen(1)

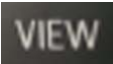

- 1  Press 2 seconds for switching screen
- 2  **[OEM → MIRRORING]**
- 3  Press 4 seconds for switch screen resolution size.

※ Only on NAV mode of dash board, the screen can be switched ※



How to connect(2)

1 How to switch screen mandatory by IR.

Only compatible on OEM screen.
: Press **1** OK button 4+ **2** MENU button 1



[R/C of interface]

2 REAR MODE

AVC TYPE
AVC TIME
CAN TYPE
REAR MODE
DEFAULT SETTING

① OEM CAM

REAR MODE
OEM CAM

② AFTER CAM

REAR MODE
AFTER CAM

③ REAR OFF

REAR MODE
REAR OFF