



2012~2015

2016~2019

2020~

TOYOTA LAND CRUISER LC200

IU50LX MANUAL

MAIN UNIT



IU50LX

Car Brand	Model	Year Range	System
TOYOTA LAND CRUISER LC200	IU50LX	2012~2015 2016~2019 2020~	

COMPONENTS

<p>1 MAIN UNIT</p> 	<p>2 POWER CABLE (2012~) JACK BY JACK</p> 	<p>3 GVIF IN CABLE(2019~)</p> 	<p>4 GVIF OUT CABLE(2019~)</p> 	<p>5 IR CABLE</p> 
<p>6 R/C</p> 	<p>7 GVIF IN CABLE(2012~2018)</p>  <p>※ OPTION ※</p>	<p>8 GVIF OUT CABLE(2012~2018)</p>  <p>※ OPTION ※</p>	<p>9 RGB CABLE</p>  <p>※ OPTION ※</p>	<p>10 AV GENDER BOARD</p>  <p>※ OPTION ※</p>
<p>11 AV IN/OUT CABLE</p>  <p>※ OPTION ※</p>	<p>12 AV GENDER CABLE</p>  <p>※ OPTION ※</p>	<p>12 IE BUS SWITCH(IB50LX) 2012~2015</p>  <p>※ OPTION ※ (2012~2015 TOUCH BOARD)</p>		

CONNECTION

(IU50LX)

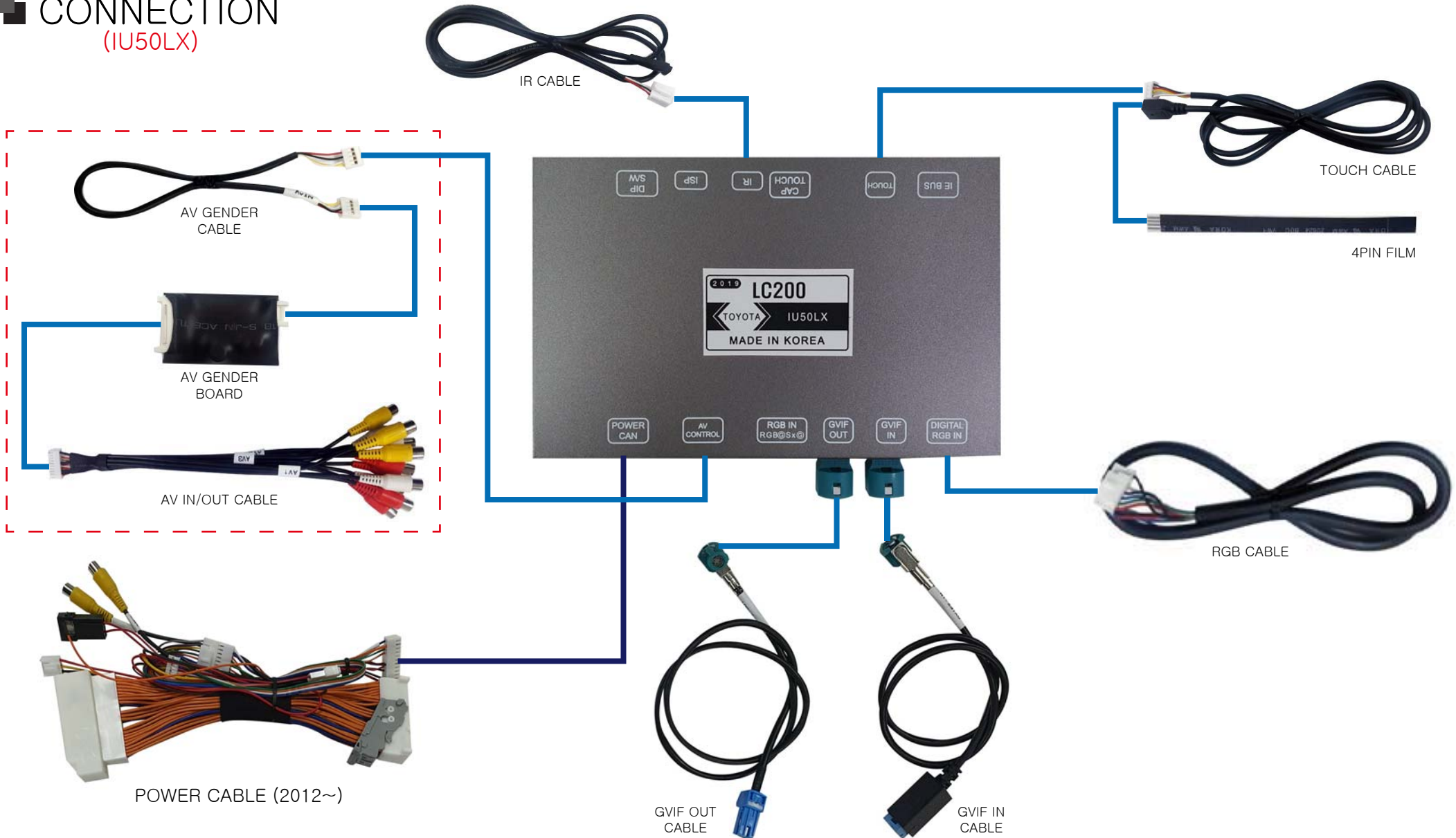

DIP S/W

OFF : ↑ (UP) / ON : ↓ (DOWN)

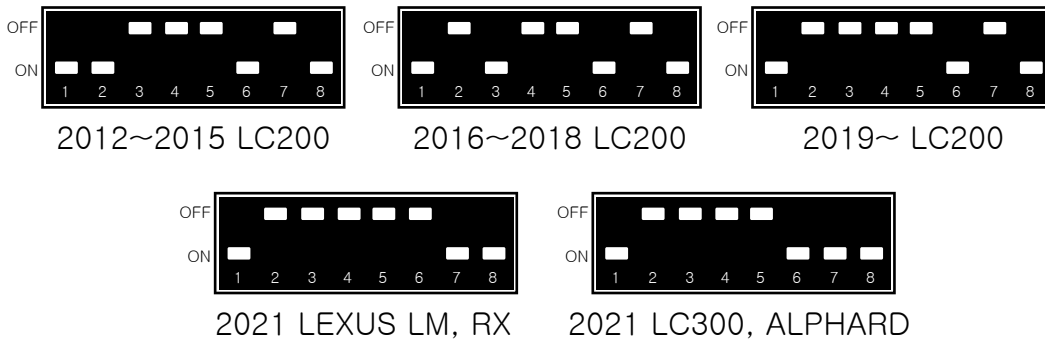

PIN	FUNCTION	DIP S/W SETTING
1	GPS INPUT MUTE	OFF : DO NOT USE GPS
		ON : USE GPS
2	VEHICLE SETTING	
3	VEHICLE SETTING	
4	REAR CAMERA	OFF : OEM CAMERA
		ON : AFTERMARKET CAMERA
5	OFF	
6	RESOLUTION SETTING	OFF : X
		ON : LC200
7	RESOLUTION SETTING	
8	ON	

IU50LX SPEC

1. INPUT SPEC

- 1 x Analog RGB Input(GPS system output)
- 1 x GVIF Input
- 1 x GVIF output
- 1 x CVBS(rear camera)
- 1 x CVBS(front camera or A/V)
- 1 x HDMI(USE FOR HDMI MODEL)
- 3 x A/V Input(Option)

2. OUTPUT SPEC

- 1 x CVBS
- 1 x Audio L/R

3. POWER SPEC

- Input power : 8VDC ~ 24VDC
- Consumption : 5WATT

4. SIZE

- 154*98*20mm(Width*Length*Height)

5. POWER 24pin

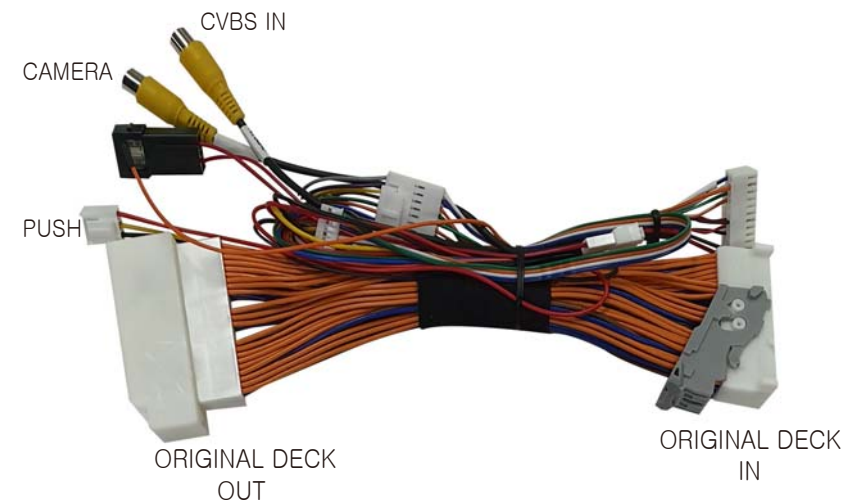

INSTALLATION

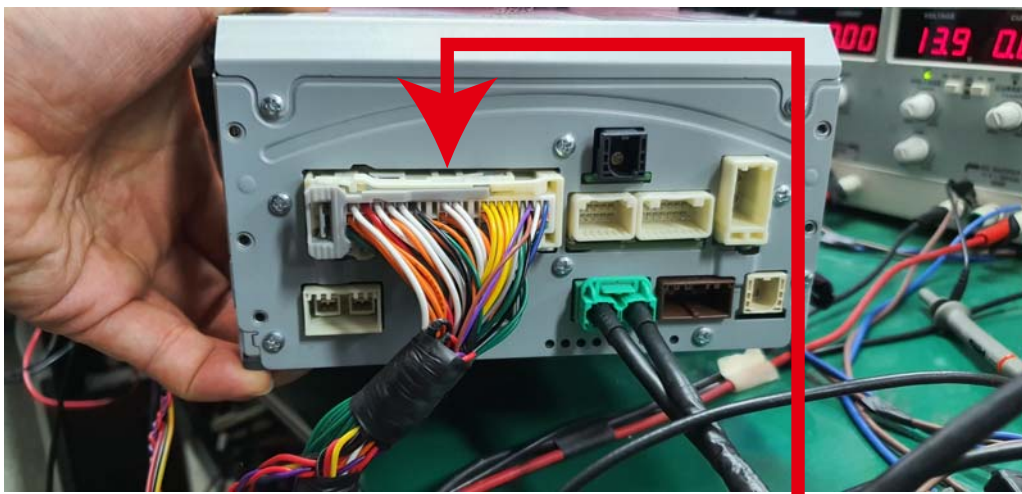

INTERFACE IN CABLE

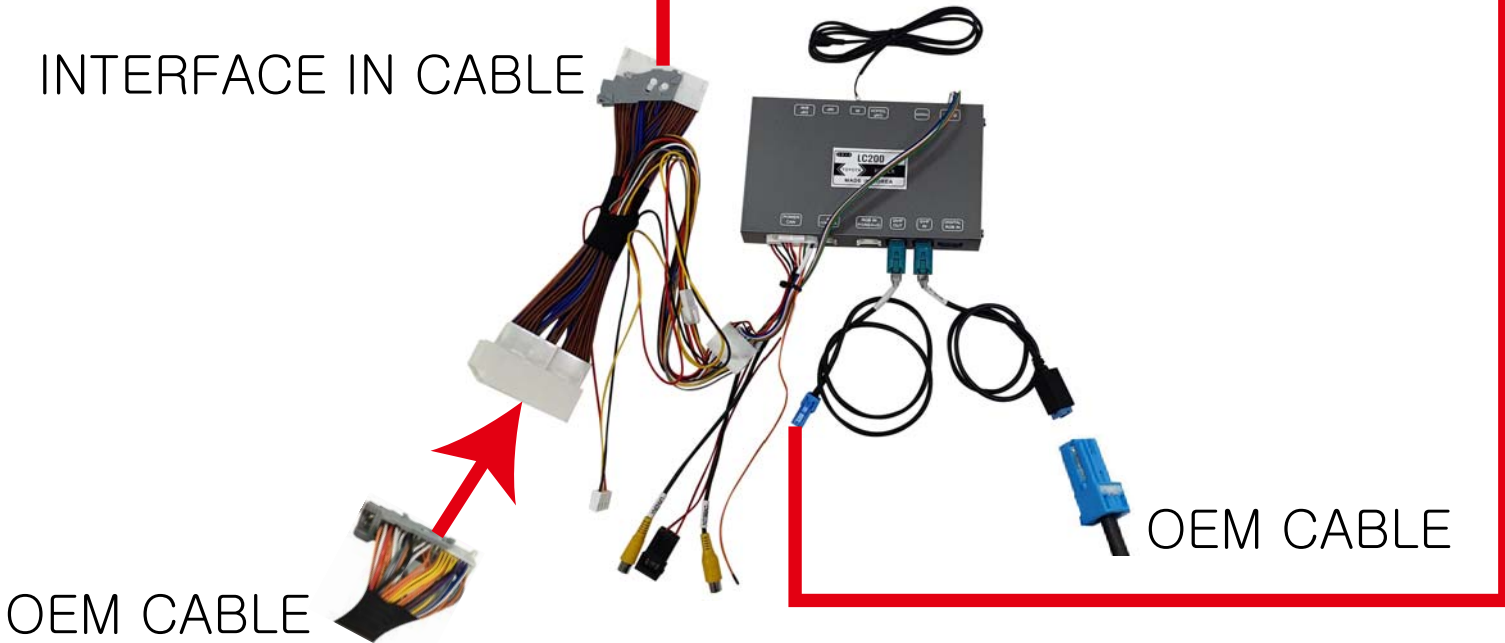

OEM CABLE

OEM CABLE

■ HOW TO SWITCH MODE – 2016~CURRENT LC200



- 1. HOLD 2S TO SWITCH MODE
- 2. HOLD 3S IN REVERSE TO SWITCH MODE BETWEEN OEM REAR CAMERA AND AFTERMARKET REAR CAMERA
- SHORT PRESS TO RETURN TO OEM DISPLAY

■ HOW TO SWITCH MODE – 2016~CURRENT LC200



-  – HOLD 2S TO ON/OFF AND SWITCH PIP MODE
-  – SHORT PRESS TO RETURN OEM DISPLAY

PIP MODES

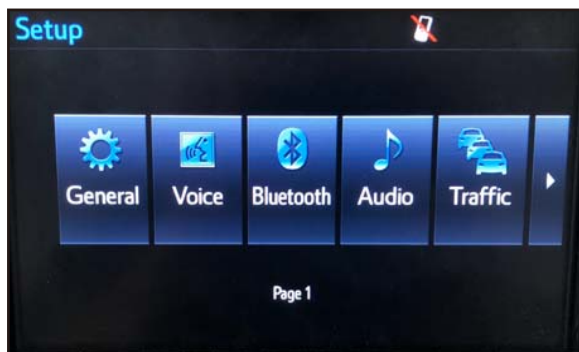

OEM DISPLAY

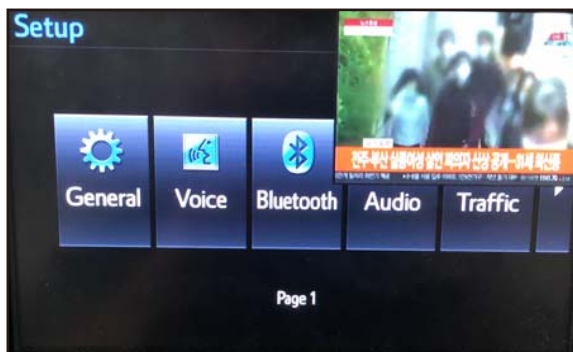

OEM + AV1

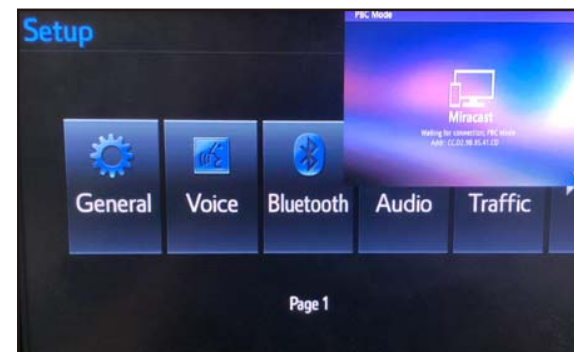

OEM + AV2



AFTERMARKET NAVI



AFTERMARKET NAVI+AV1





AFTERMARKET NAVI+AV2

PIP MODE ONLY POSSIBLE TO DISPLAY WHEN IN OEM OR AFTERMARKET NAVIGATION DISPLAY.
 SCREEN WILL DISPLAY FULL SCREEN WHEN IN AV1 AND AV2

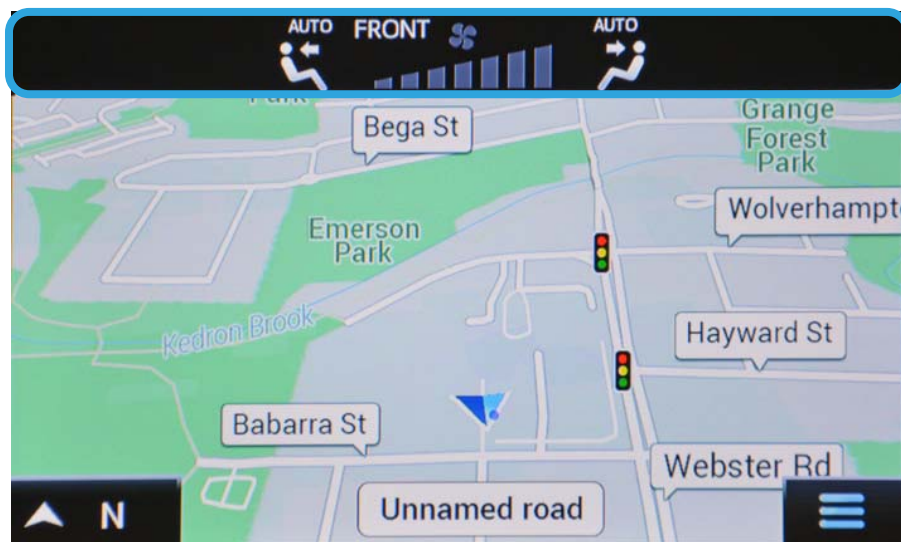
HOW TO SWITCH MODE – 2016~CURRENT LC200



-  – SHORT PRESS TO SHOW FULL CLIMATE MENU
-  – SHORT PRESS TO SHOW ON TOP

HOW TO SWITCH MODE – 2012~2015 LC200



※ OPTION ※

IE BUS SWITCH(IB50LX)



(2012~2015
TOUCH BOARD)

- 1. HOLD 2S TO SWITCH MODE
- 2. HOLD 3S IN REVERSE TO SWITCH MODE BETWEEN OEM REAR CAMERA AND AFTERMARKET REAR CAMERA
- SHORT PRESS TO RETURN TO OEM DISPLAY

■ HOW TO SWITCH MODE – 2012~2015 LC200

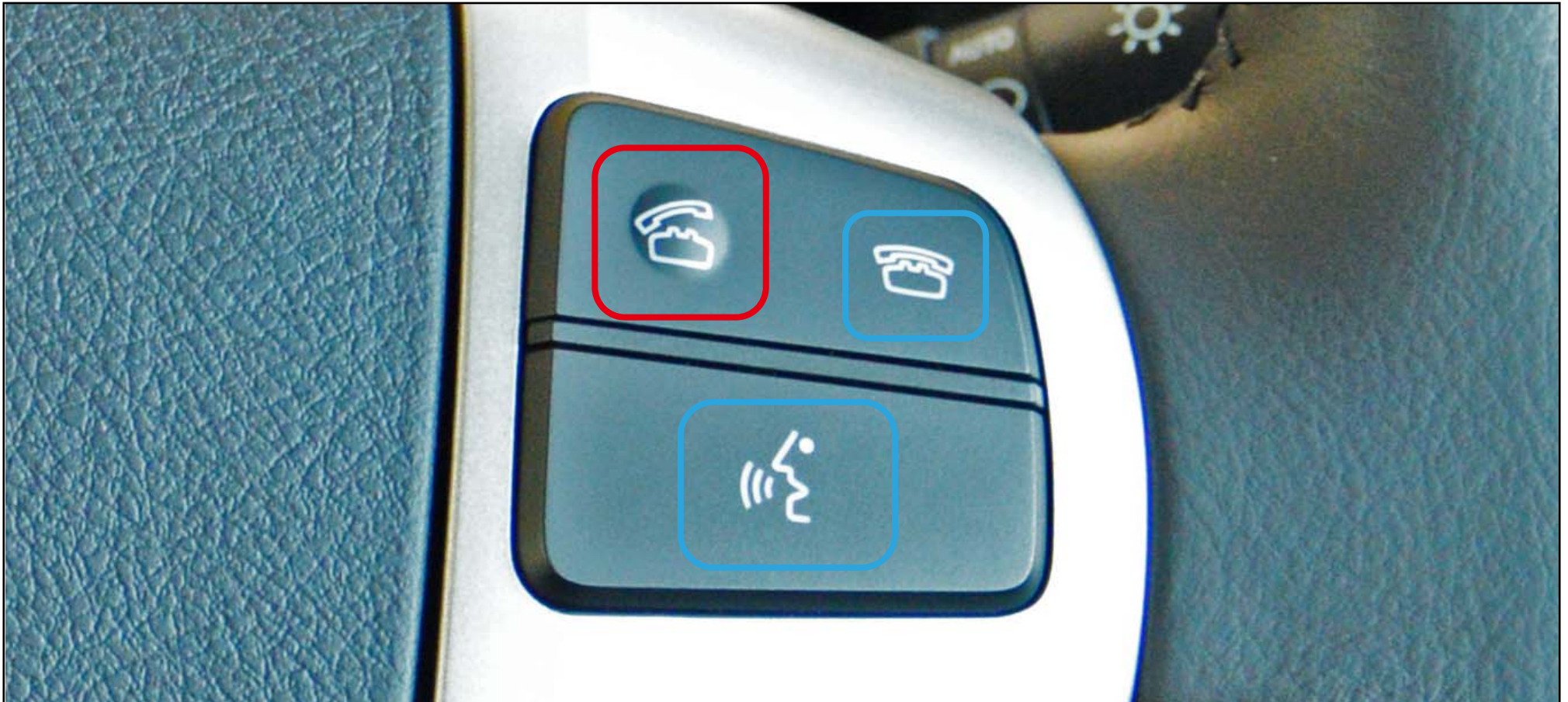

-  – HOLD 2S TO ON/OFF AND SWITCH PIP MODE
-  – SHORT PRESS TO OEM DISPLAY

PIP MODES

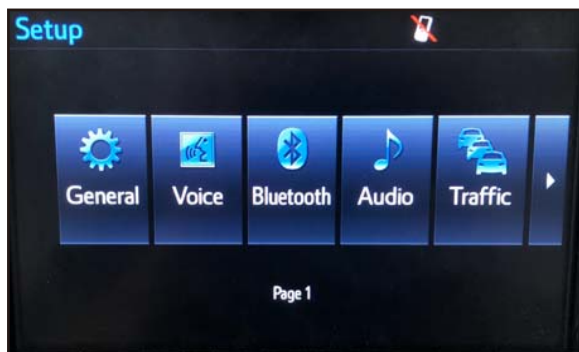

OEM DISPLAY

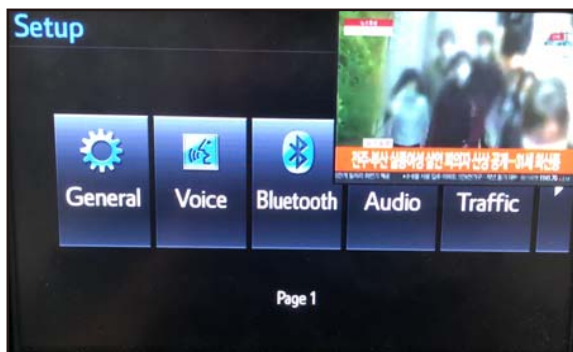

OEM + AV1

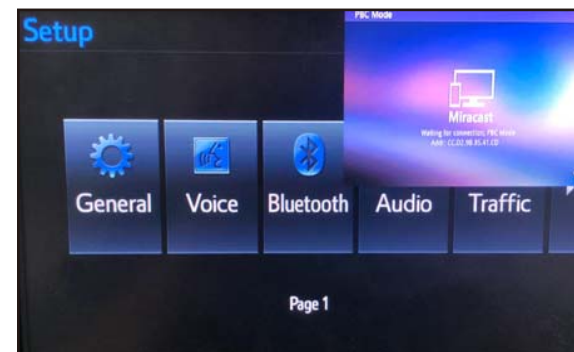

OEM + AV2



AFTERMARKET NAVI



AFTERMARKET NAVI+AV1





AFTERMARKET NAVI+AV2

PIP MODE ONLY POSSIBLE TO DISPLAY WHEN IN OEM OR AFTERMARKET NAVIGATION DISPLAY.

SCREEN WILL DISPLAY FULL SCREEN WHEN IN AV1 AND AV2

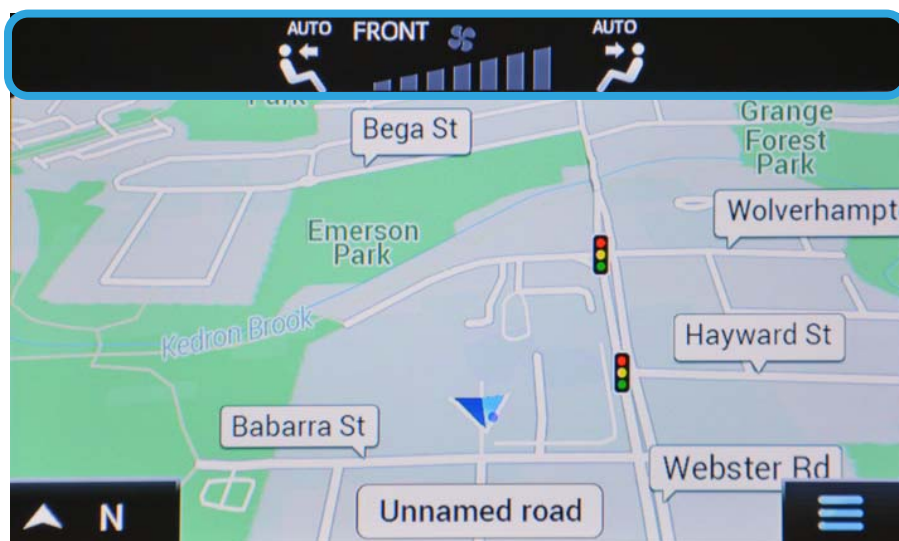
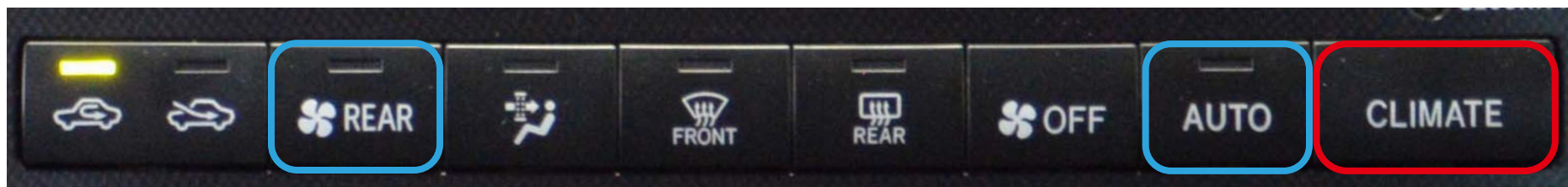
HOW TO SWITCH MODE – 2012~2015 LC200



-  – SHORT PRESS TO SHOW FULL CLIMATE MENU
-  – SHORT PRESS TO SHOW ON TOP

HOW TO CONNECT VIDEO AUDIO WHEN YOU ONLY USE ONE AV INPUT

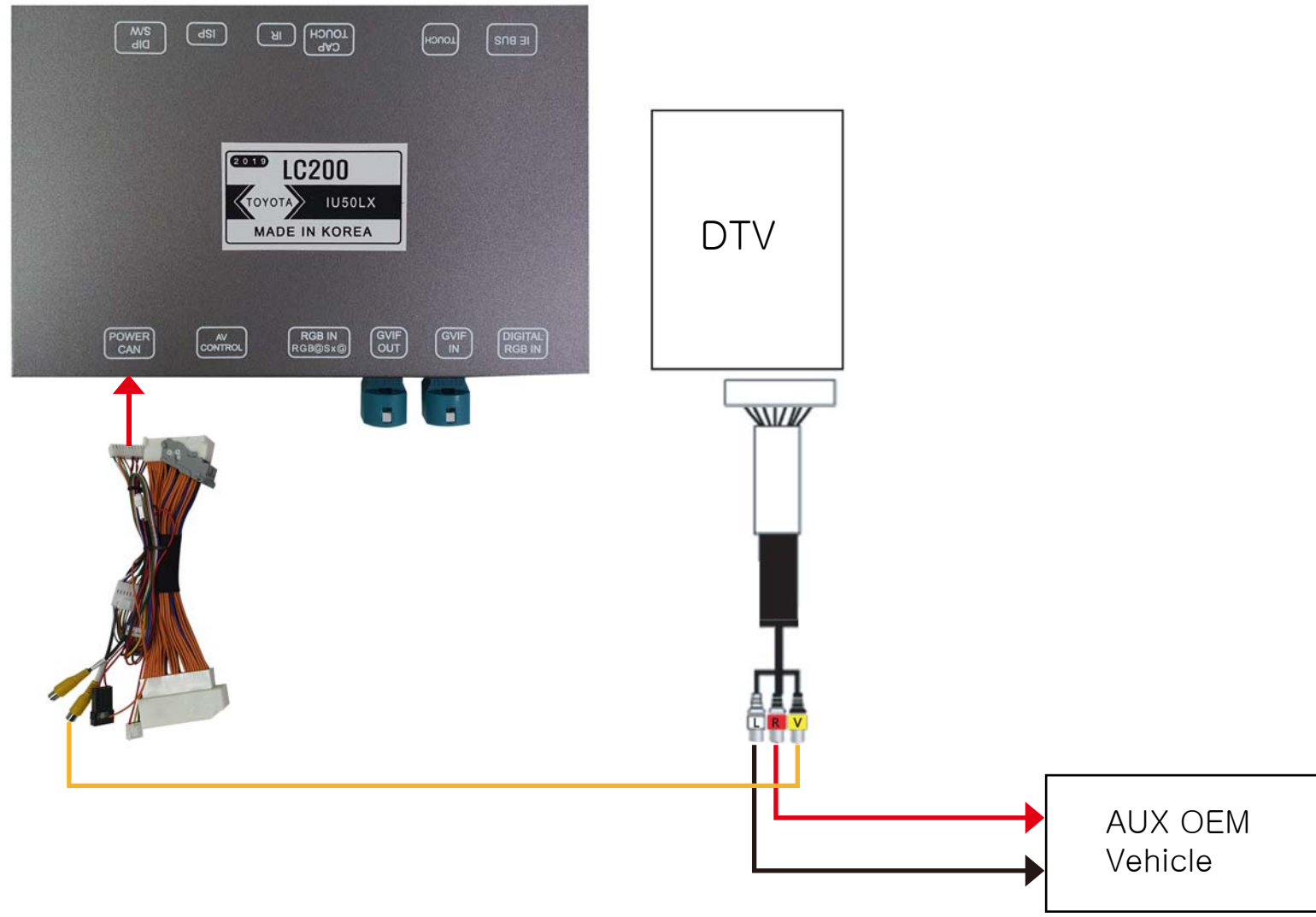

HOW TO CONNECT VIDEO AUDIO WHEN YOU USE MORE THAN 2 AV INPUTS

