



2019 LAMBORGHINI URUS 10.1" DUO

2019 AUDI A6, A7, A8, Q8 10.1" DUO

2019 AUDI A1, A4, Q3 10.1" SINGLE

2019 VOLKSWAGEN TOUAREG 15"

2018 PORSCHE CAYENNE 12.3"

2019 PORSCHE MACAN 12.3"

2020 PORSCHE 911 11"

MANUAL

1. IU30VH-HDMI









## MAIN BOARD

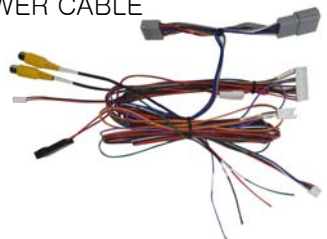

IU30VH-HDMI

Car Brand	Model	Year Range	Screen Size
LAMBORGHINI	URUS	2019	10.1" DUO
PORSCHE	CAYENNE	2018	12.3"
	MACAN	2019	12.3"
	911	2020	11"
AUDI	A6, A7, A8, Q8	2019	10.1" DUO
	A1, A4, Q3	2019	10.1" SINGLE
VOLKSWAGEN	TOUAREG	2019	15"

# COMPONENTS

<p><b>1</b> MAIN UNIT</p> 	<p><b>2</b> POWER CABLE</p> 	<p><b>3</b> LVDS IN CABLE</p> 	<p><b>4</b> IR CABLE</p> 
<p><b>5</b> HDMI AUDIO CABLE</p> 	<p><b>6</b> AV IN/OUT CABLE</p>  <p>※ OPTION ※</p>	<p><b>7</b> AV GENDER CABLE</p>  <p>※ OPTION ※</p>	<p><b>8</b> AV GENDER BOARD</p>  <p>※ OPTION ※</p>
<p><b>9</b> RGB CABLE</p>  <p>※ OPTION ※</p>	<p><b>10</b> REMOTE CONTROL</p>  <p>※ OPTION ※</p>		

※ PLEASE CONNECT B+, IF CONNECT ACC WILL HAVE REALLY SHORT BLINK JUST ONCE WHEN SWITCH FROM AFTER MARKET NAVI TO OEM. ※

# HOW TO CONNECT (IU30VH-HDMI)

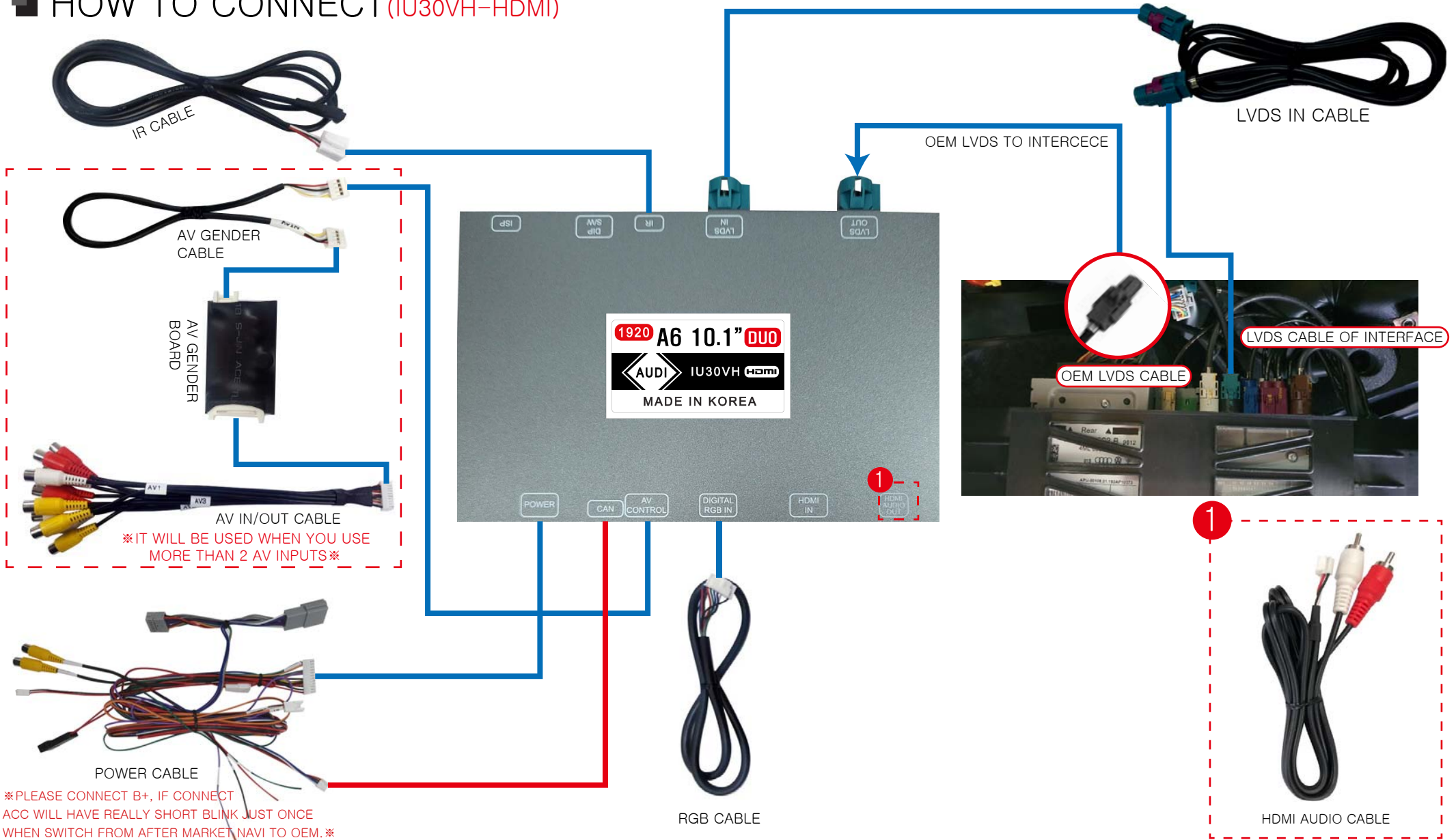

※ PLEASE CONNECT B+, IF CONNECT ACC WILL HAVE REALLY SHORT BLINK JUST ONCE WHEN SWITCH FROM AFTER MARKET NAVI TO OEM. ※

## DIP S/W OFF : ↑ (UP) / ON : ↓ (DOWN)

**AUDI A8 DUAL**  
**AUDI 8.8 INCH DUAL**  
**AUDI 8.8 INCH**  
**AUDI SINGLE**  
**PCM5.0**  
**PCM5.0 MACAN**  
**VW TOUAREG**  
**VW TOUAREG DRV R**  
**AUDI SINGLE A4**  
**AUDI SINGLE MIB3**  
**AUDI A4 SINGLE MIB3 (1560 X 720)**  
**PCM6.0(CAYENNE)-JAPAN**  
**PCM6.0(CAYENNE)-RUSSIA**  
**PCM6.0(CAYENNE)-TAIWAN**  
**AUDI A8 DUAL TOP**  
**2020 AUDI Q7 DUAL 10.1inch(1540x720)**  
**AUDI MIB3 DUAL**  
**AUDI A6 MIB3 TOP DUAL MONITOR**

DIP\_SW8 ON  
 DIP\_SW8 ON  
 DIP\_SW8 OFF  
 DIP\_SW8 OFF  
 DIP\_SW8 OFF  
 DIP\_SW8 OFF  
 DIP\_SW8 OFF  
 DIP\_SW8 OFF

PIN	FUNCTION	DIP S/W SETTING
1	GPS INPUT MUTE	OFF : DO NOT USE GPS / ON : USE GPS
2	FUNCTION SETTING	OFF : TV TOUCH (IU30VH) / ON : TV FREE (IU30VHF)
3	TV FREE ON/OFF	OFF : TV FREE (FUNCTION OFF) / ON : TV FREE (FUNCTION ON)
4	REAR CAMERA	OFF : OEM CAMERA / ON : AFTERMARKET CAMERA
5,6,7,8,9	VEHICLE SETTING	
10	ON	

※ PLEASE CONNECT B+, IF CONNECT ACC WILL HAVE REALLY SHORT BLINK JUST ONCE WHEN SWITCH FROM AFTER MARKET NAVI TO OEM. ※

## IU30VH-HDMI SPEC

- INPUT SPEC**
  - 1 x Analog RGB Input(GPS system output)
  - 1 x NAVI LVDS Input(GPS system output)
  - 1 x LVDS Input
  - 1 x LVDS output
  - 1 x CVBS(rear camera)
  - 1 x CVBS(front camera or A/V)
  - 1 x HDMI(THE MODEL WHICH COMPATIBLE WITH HDMI)
  - 3 x A/V Input(Option)
- OUTPUT SPEC**
  - 1 x CVBS
  - 1 x Audio L/R
- POWER SPEC**
  - Input power : 8VDC ~ 24VDC
  - Consumption : 5WATT

### 4. SIZE

157\*98\*19mm(Width\*Length\*Height)

### 5. POWER 24pin

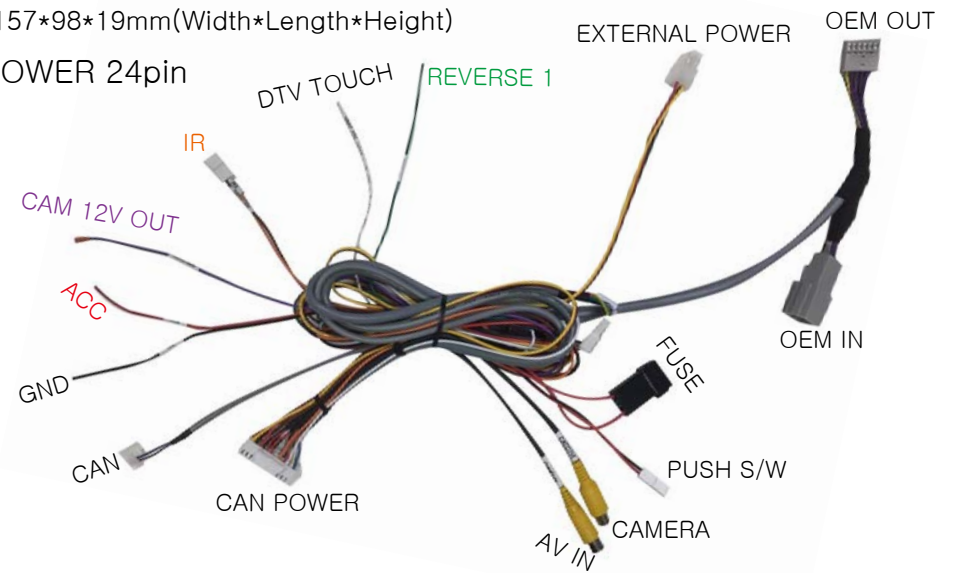

# HOW TO CONNECT AUDI A6, A7, A8, Q8, URUS, TOUAREG

※PLEASE CONNECT B+, IF CONNECT ACC WILL HAVE REALLY SHORT BLINK JUST ONCE WHEN SWITCH FROM AFTER MARKET NAVI TO OEM.※

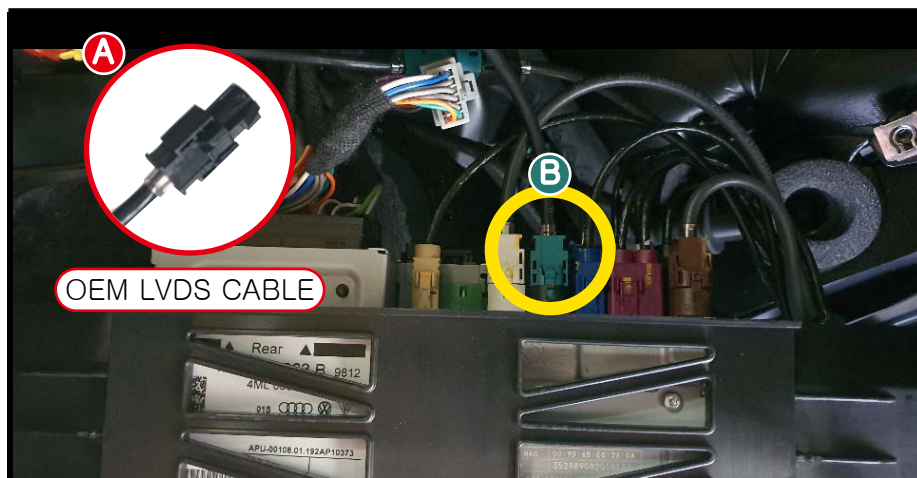

1. PLEASE PULL OUT OEM LVDS CABLE **A**, AND LVDS IN CABLE **B** OF INTERFACE CONNECT WITH HEAD UNIT.

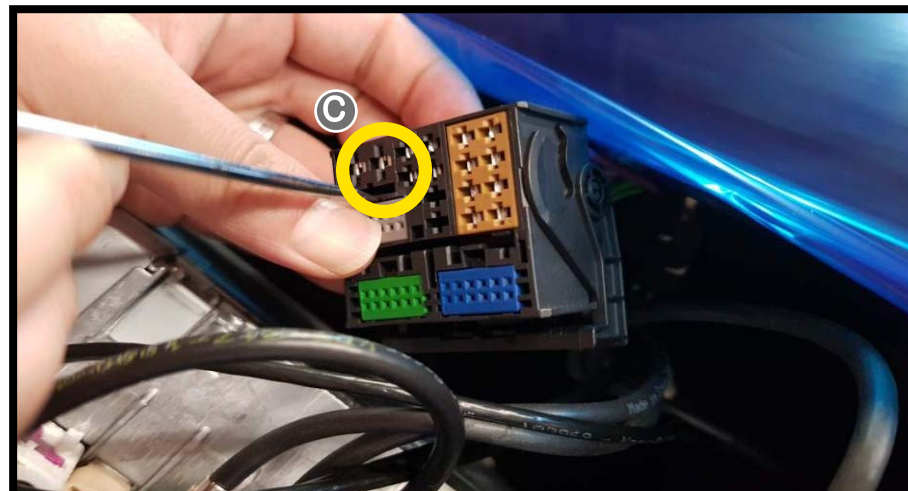

2. PLEASE REMOVE THE OEM CONNECTOR **C**.

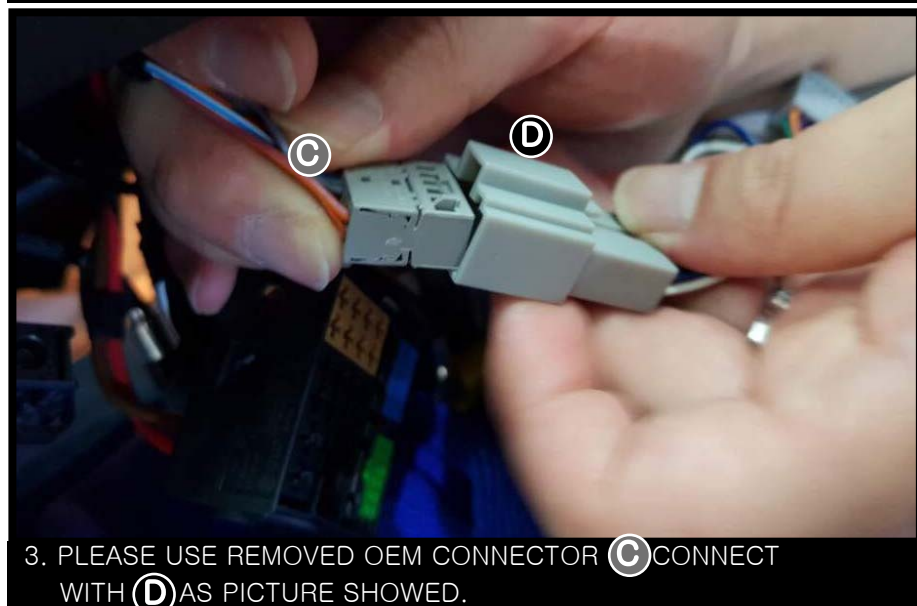

3. PLEASE USE REMOVED OEM CONNECTOR **C** CONNECT WITH **D** AS PICTURE SHOWN.

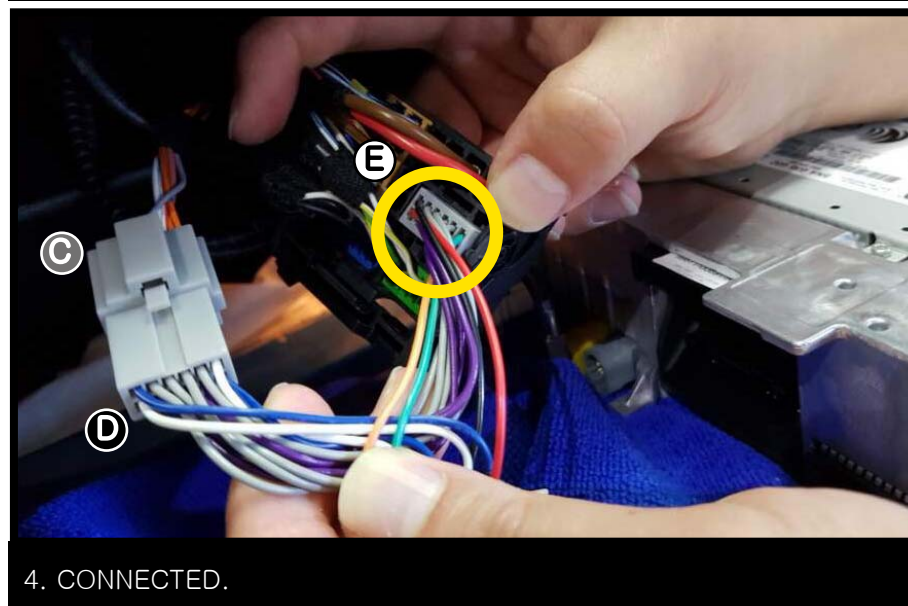

4. CONNECTED.

# HOW TO SWITCH SCREEN(AUDI A1, A4, Q3 10.1" SINGLE)

1



PRESS  FOR 2S WILL SWITCH SCREEN

OEM → GPS → AV1 → AV2 → AV3 → HDMI

# HOW TO SWITCH SCREEN AUDI A6, A7, A8, Q8 10.1" DUO

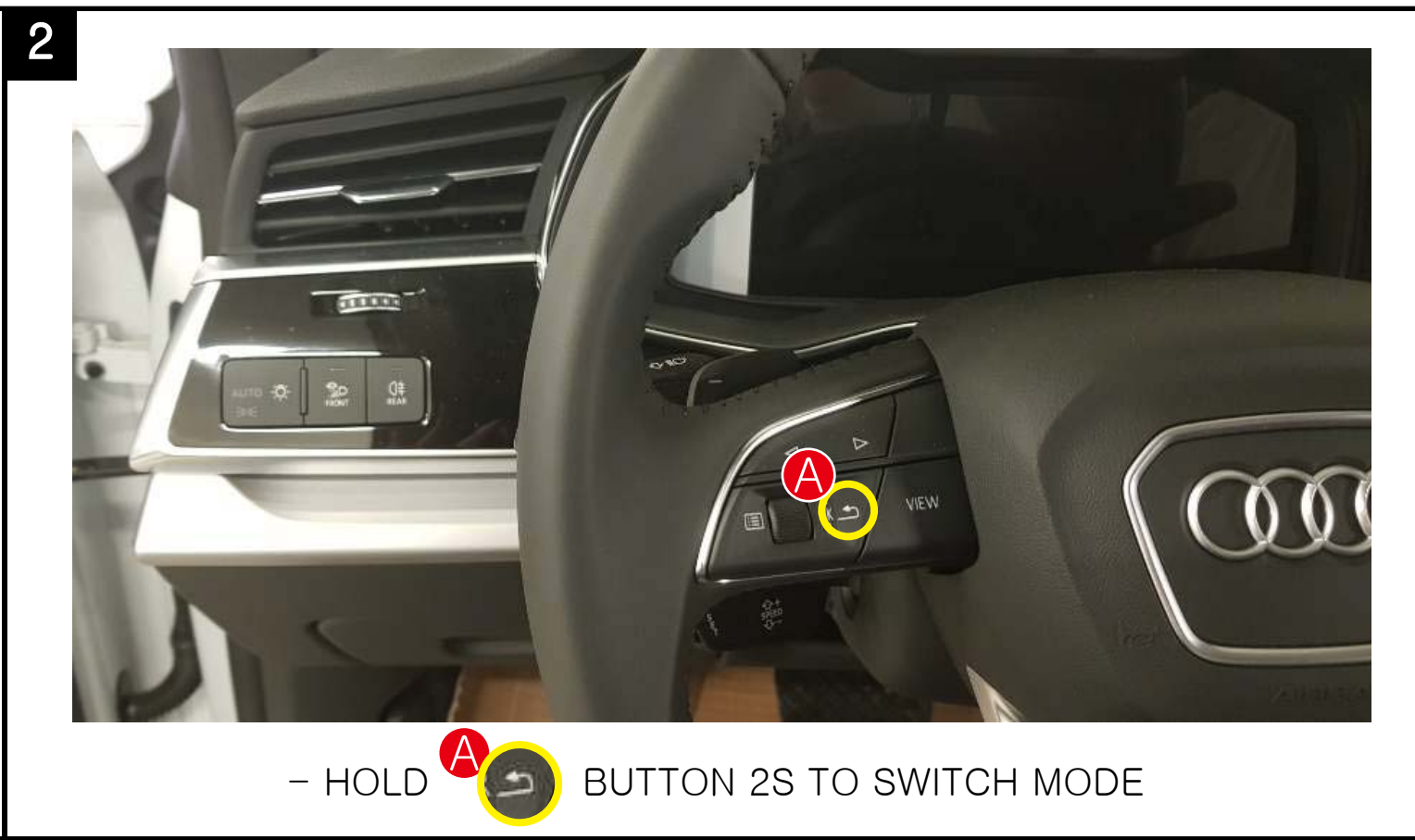

- HOLD **A** BUTTON 2S TO SWITCH MODE

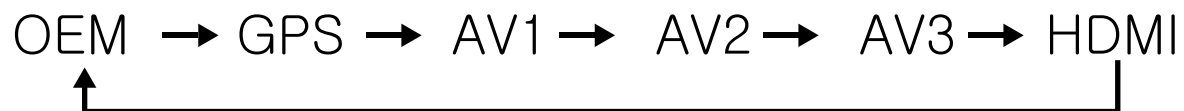

\*PLEASE CONNECT B+, IF CONNECT ACC WILL HAVE REALLY SHORT BLINK JUST ONCE WHEN SWITCH FROM AFTER MARKET NAVI TO OEM.\*



# HOW TO SWITCH SCREEN URUS 10.1" DUO

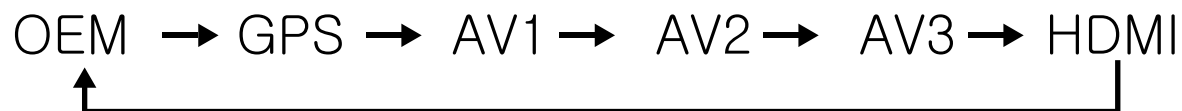
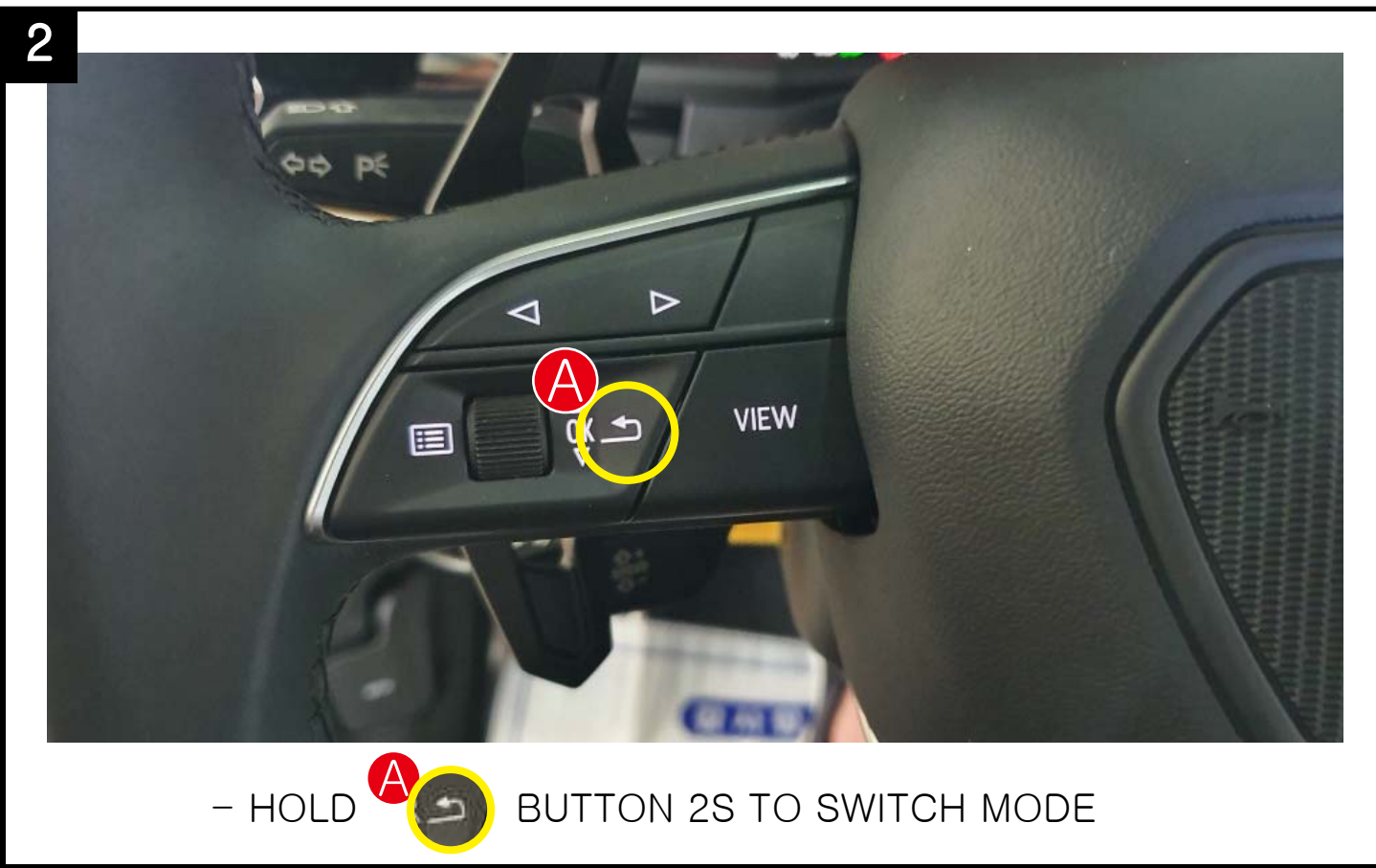
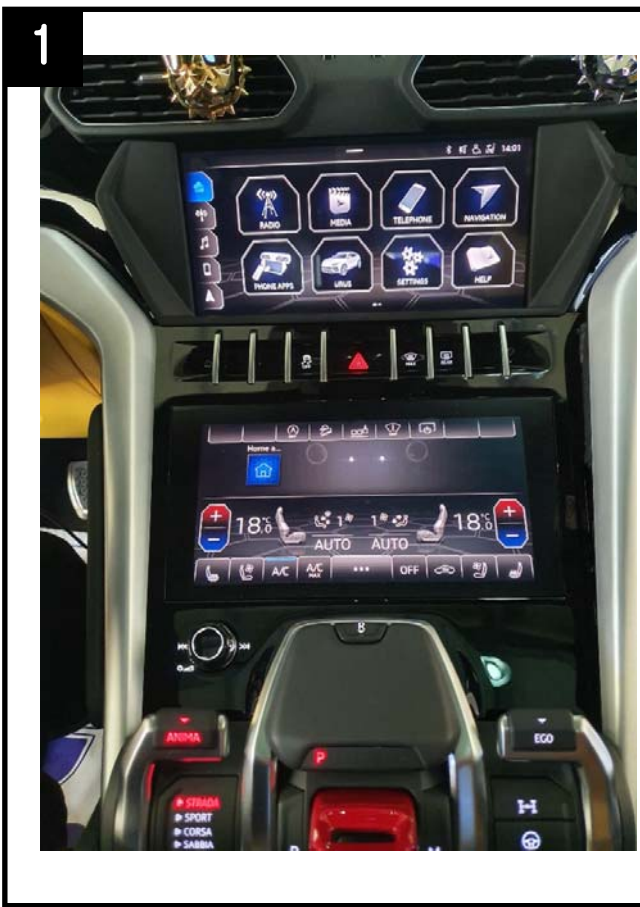

\*PLEASE CONNECT B+, IF CONNECT ACC WILL HAVE REALLY SHORT BLINK JUST ONCE WHEN SWITCH FROM AFTER MARKET NAVI TO OEM.\*

# HOW TO SWITCH SCREEN TOUAREG 15”

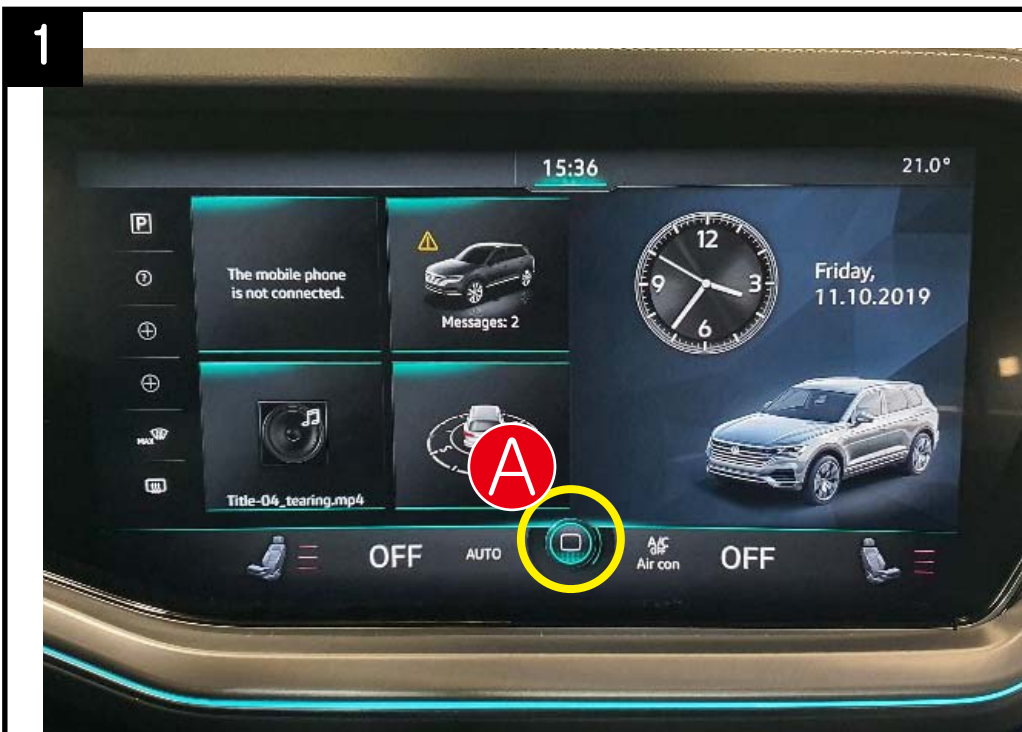

- HOLD **A**  BUTTON 2S TO SWITCH MODE

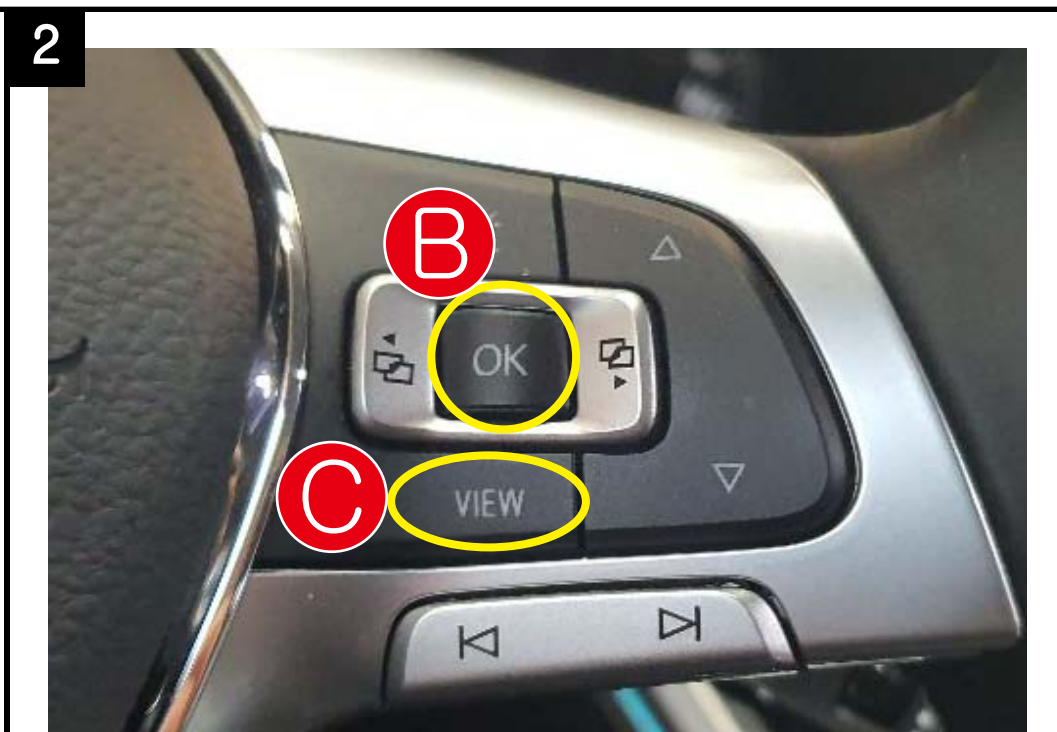

- HOLD **B**  , **C**  BUTTON 2S TO SWITCH MODE

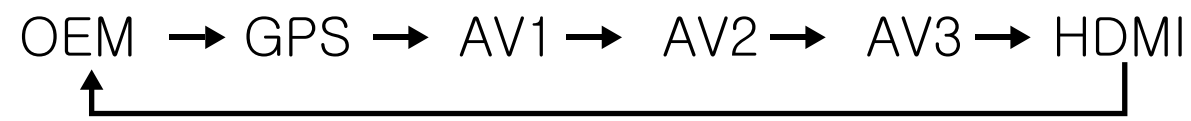

\*PLEASE CONNECT B+, IF CONNECT ACC WILL HAVE REALLY SHORT BLINK JUST ONCE WHEN SWITCH FROM AFTER MARKET NAVI TO OEM.\*

# TOUAREG 15" METHOD OF MODE SWITCH(RTC FUNCTION)

1



(OSD MENU -> SETTING -> RTC -> ON)

- HOLD **A** **OK** BUTTON 3S TO SWITCH BETWEEN FACTORY REAR CAMERA AND AFTERMARKET REAR INPUT.(VEHICLE WITH FACTORY REAR CAMERA)

# HOW TO SWITCH SCREEN

## 1 CAYENNE & MACAN



- HOLD **A** **NAV** BUTTON 3S TO SWITCH MODE

## 2 911

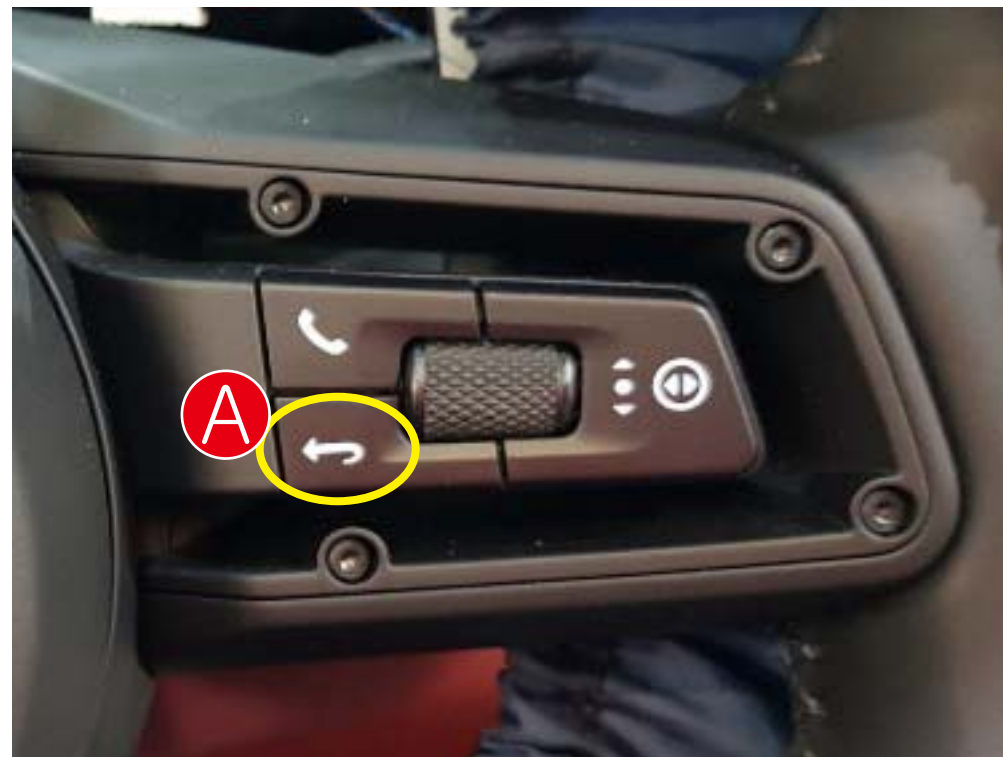

- HOLD **A** **NAV** BUTTON 3S TO SWITCH MODE



# HOW TO SWITCH SCREEN CAYENNE & MACAN (VIDEO IN MOTION, RECOGNIZATION OF SENSOR FUNCTION)

1



- HOLD **A**  BUTTON 7S TO SET VIDEO IN MOTION ON/OFF

- HOLD **B**  BUTTON 7S TO SET RECOGNIZATION OF SENSOR ON/OFF

## ■ CAYENNE & MACAN METHOD OF MODE SWITCH(RTC FUNCTION)

1



(OSD MENU -> SETTING -> RTC -> ON)

- HOLD  BUTTON 3S TO SWITCH BETWEEN FACTORY REAR CAMERA AND AFTERMARKET REAR INPUT.(VEHICLE WITH FACTORY REAR CAMERA)

# HOW TO SWITCH SCREEN CAYENNE & MACAN (NAVI → PIP)

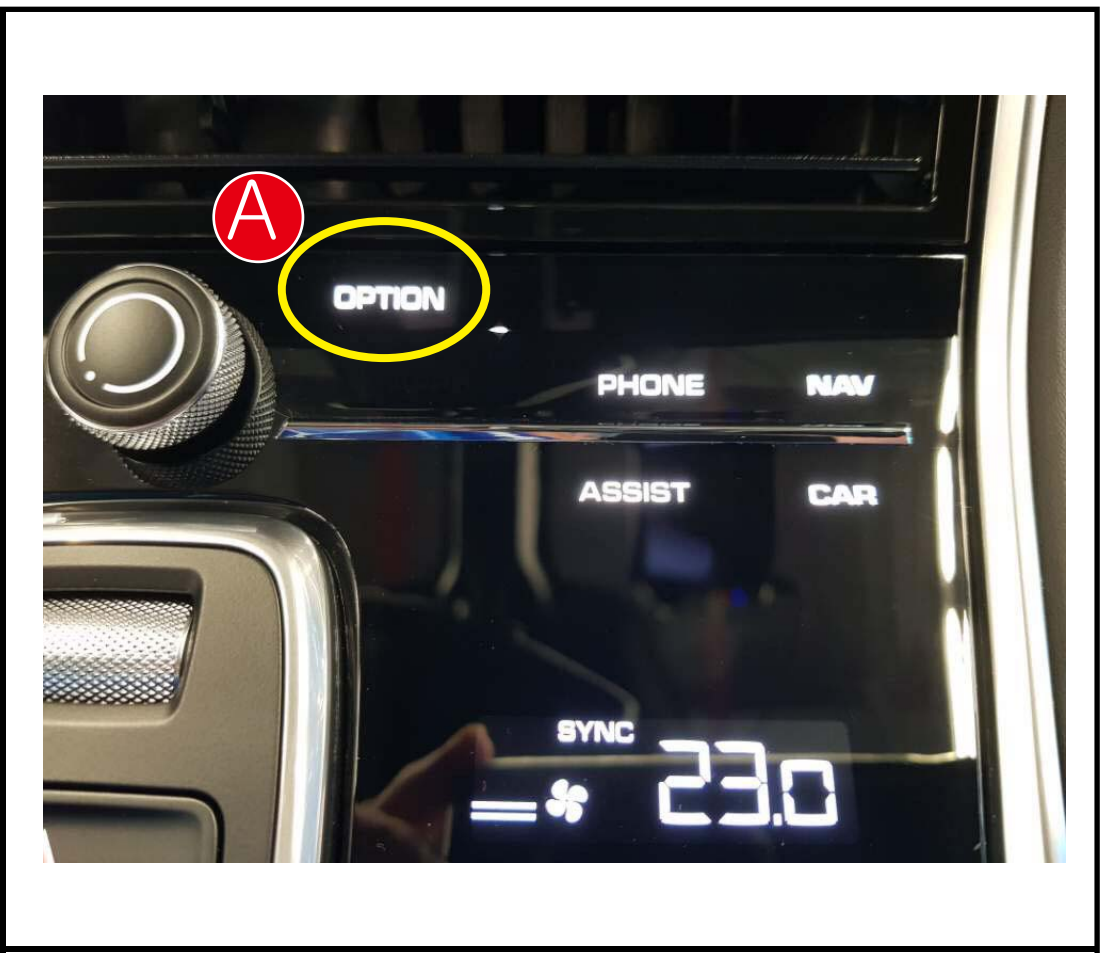
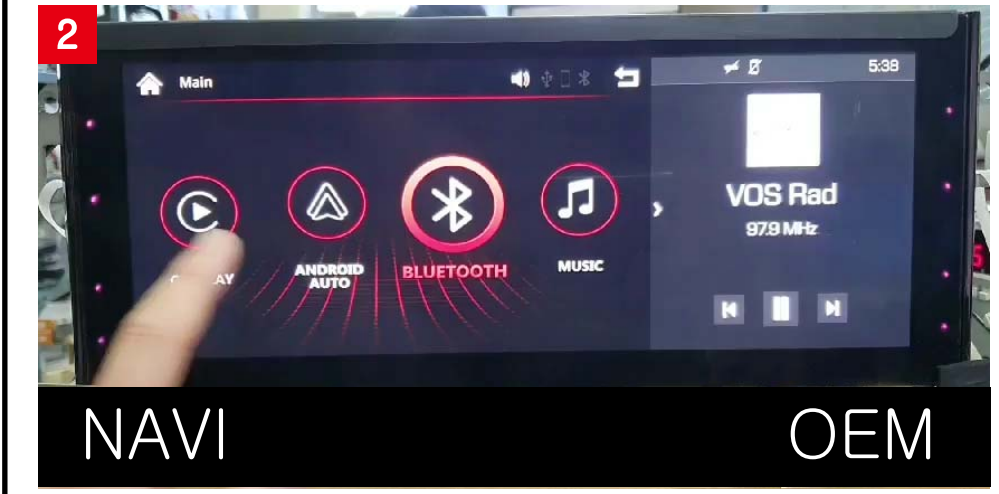
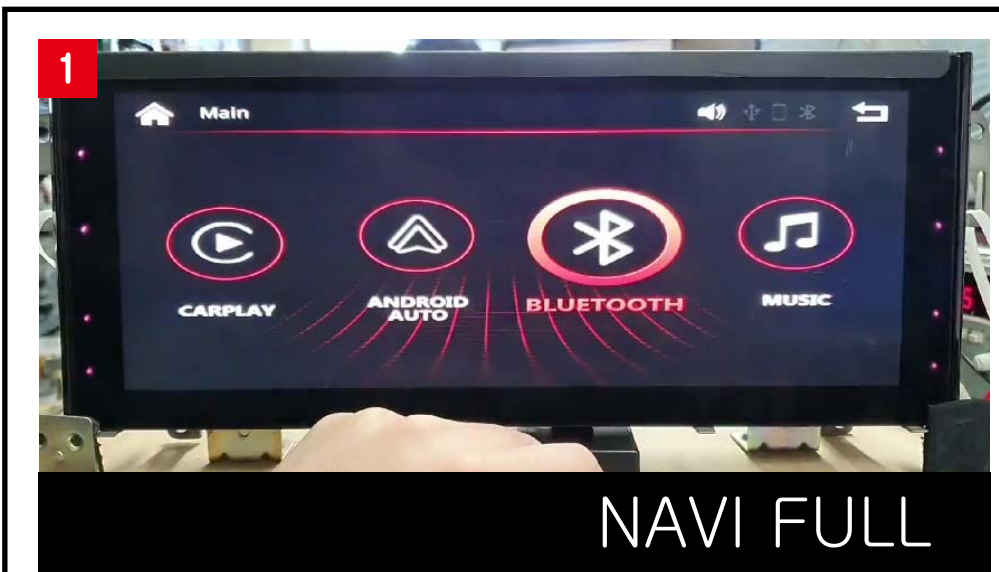

- HOLD BUTTON 2S LONG TO SWITCH PIP MODE

# HOW TO SWITCH SCREEN CAYENNE & MACAN(AV → PIP)

**1** AV FULL

**2** AV OEM

**3** OEM AV

**4** OEM AV

**5** AV OEM

**OEM FULL**

**A** **OPTION**

PHONE NAV  
ASSIST CAR  
SYNC 23.0

- HOLD **A** **OPTION** BUTTON 2S LONG TO SWITCH PIP MODE



# HOW TO CONNECT VIDEO AUDIO WHEN YOU ONLY USE ONE AV INPUT

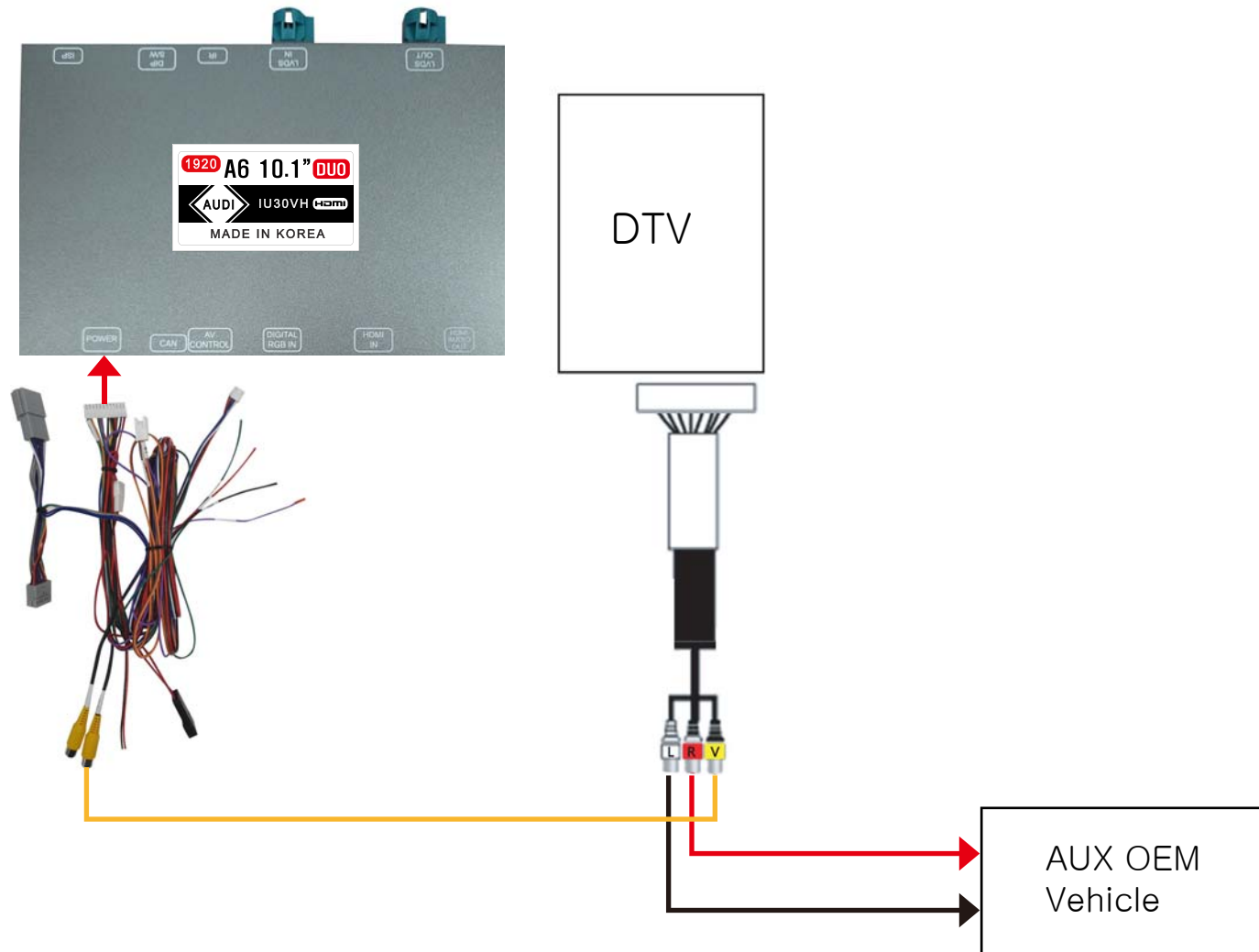

# HOW TO CONNECT VIDEO AUDIO WHEN YOU USE MORE THAN 2 AV INPUTS

